

Product data sheet

Characteristics

XUK2APBNM12R

Photoelectric sensors XU, XUK, receiver, Sn 30 m, 12...24 VDC, M12



Product availability: Non-Stock - Not normally stocked in distribution facility

Price*: 69.00 USD



Main

Range of Product	Telemecanique Photoelectric sensors XU
Series name	General purpose single mode
Electronic sensor type	Photo-electric sensor receiver
Sensor name	XUK
Sensor design	Compact 50 x 50
Detection system	Thru beam
Material	Plastic
Type of output signal	Discrete
Supply circuit type	DC
Wiring Technique	3-wire
Discrete output type	PNP
Discrete output function	1 NC
Electrical connection	1 male connector M12, 4 pins
Product Specific Application	-
Emission	Infrared thru beam
[Sn] nominal sensing distance	98.43 Ft (30 m) thru beam need a transmitter XUK2AKSNM12T

Complementary

Enclosure Material	PBT
Lens material	PMMA
Maximum sensing distance	147.64 Ft (45 m) thru beam
Output Type	Solid state
Add on output	Without
Status LED	1 LED yellow)output state
[Us] rated supply voltage	12...24 V DC with reverse polarity protection
Supply voltage limits	10...36 V DC
Switching capacity in mA	<= 100 mA overload and short-circuit protection)
Switching frequency	<= 250 Hz
Maximum voltage drop	<1.5 V closed state)

Current consumption	<= 35 mA no-load
Maximum delay first up	15 Ms
Maximum delay response	2 Ms
Maximum delay recovery	2 Ms
Setting-up	Without sensitivity adjustment
Maximum Depth	1.97 In (50 mm)
Maximum Height	1.97 In (50 mm)
Maximum Width	0.71 In (18 mm)
Net Weight	0.17 Lb(US) (0.075 kg)

Environment

Product Certifications	CE UL CSA
Ambient Air Temperature for Operation	-13...131 °F (-25...55 °C)
Ambient Air Temperature for Storage	-40...158 °F (-40...70 °C)
Vibration resistance	7 gn +/- 1.5 mm 10...55 Hz) IEC 60068-2-6
Shock resistance	30 gn 11 ms) IEC 60068-2-27
IP degree of protection	IP65 double insulation IEC 60529



Ordering and shipping details

Category	21571 - SENSORS, ELECTRONIC BASIC XU & XS
Discount Schedule	DS2
GTIN	03389110161939
Nbr. of units in pkg.	1
Package weight(Lbs)	2.22 Oz (63 g)
Returnability	No
Country of origin	ID

Packing Units

Unit Type of Package 1	PCE
Package 1 Height	1.69 In (4.3 cm)
Package 1 width	2.60 In (6.6 cm)
Package 1 Length	3.78 In (9.6 cm)
Unit Type of Package 2	S02
Number of Units in Package 2	44
Package 2 Weight	7.11 Lb(US) (3.227 kg)
Package 2 Height	5.91 In (15 cm)
Package 2 width	11.81 In (30 cm)
Package 2 Length	15.75 In (40 cm)

Offer Sustainability

Sustainable offer status	Green Premium product
California proposition 65	WARNING: This product can expose you to chemicals including: Diisononyl phthalate (DINP), which is known to the State of California to cause cancer, and Diisodecyl phthalate (DIDP), which is known to the State of California to cause birth defects or other reproductive harm. For more information go to www.P65Warnings.ca.gov
REACH Regulation	 REACH Declaration
EU RoHS Directive	Pro-active compliance (Product out of EU RoHS legal scope)  EU RoHS Declaration
Mercury free	Yes
RoHS exemption information	 Yes

Environmental Disclosure	Product Environmental Profile
Circularity Profile	End Of Life Information

Contractual warranty

Warranty	18 months
----------	-----------

Dimensions

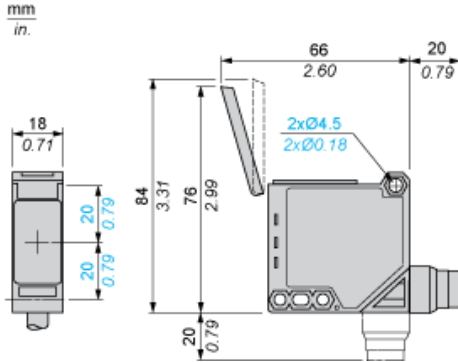

Mounting and Clearance

Possible Orientation of Elbowed Connector

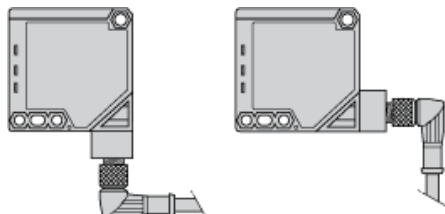

Wiring Schemes

M12 Connector

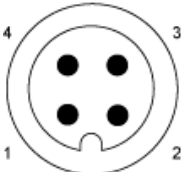

- 1: (+)
- 3: (-)
- 4: OUT/Output

PNP Outputs



Detection Curves

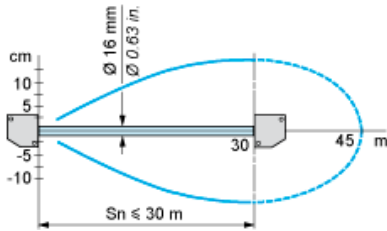

Product Life Status : Commercialised